

FDF-SM-36C

DISTRIBUIDOR DE FIBRA ÓPTICA

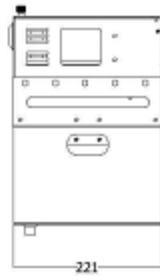
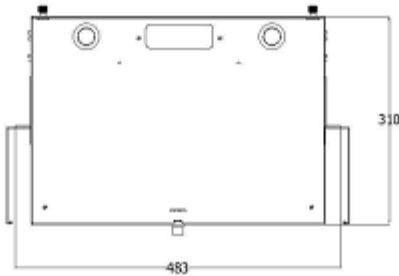
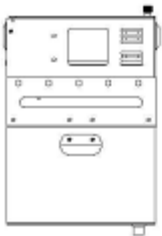

| ITEM. | FDF-SM-36C |
|--------------------|-------------------|
| Size (L*W*H) | 483 X 310 X 221 |
| No. of Splice Tray | 2 |
| Tray Capacity | 24C (Max. 48C) |
| Module Capacity | L : 5ea / R : 5ea |
| Adapter Type | SC Duplex |
| Adapter Capacity | 36 |

Opticube®

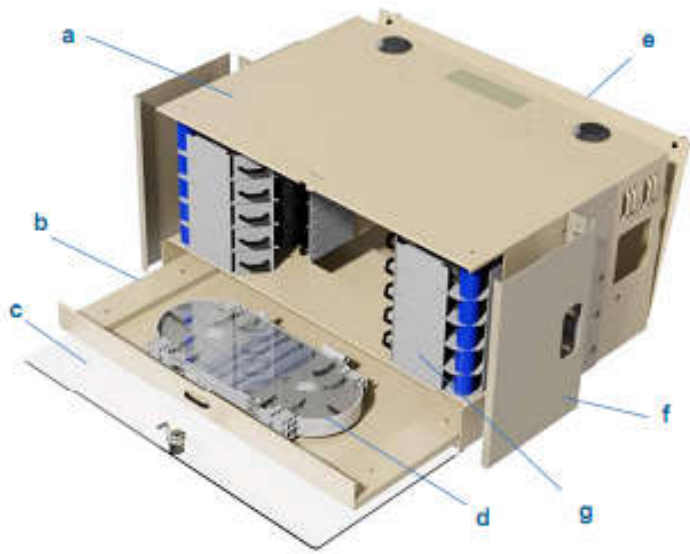

| No. | Feature | No. | Feature |
|-----|-------------------|-----|----------------------------------|
| a | Body | e | Rear Door |
| b | Splice Tray Panel | f | Rack Bracket & Jumper Cord Guide |
| c | Front Door | g | Module |
| d | Splice Tray | | |

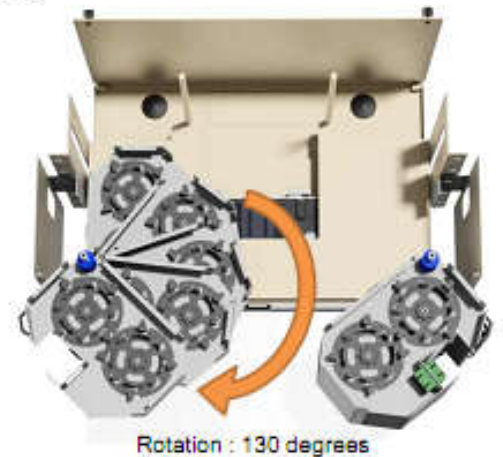
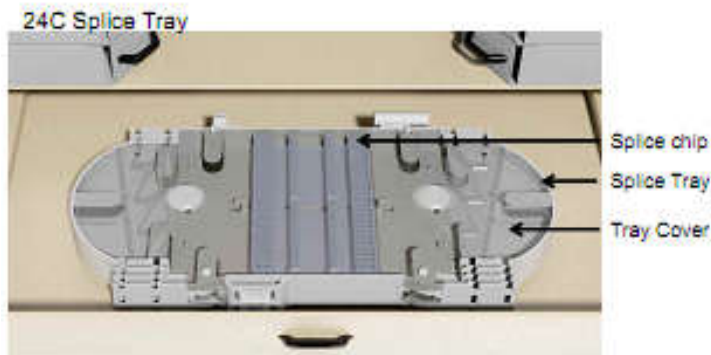
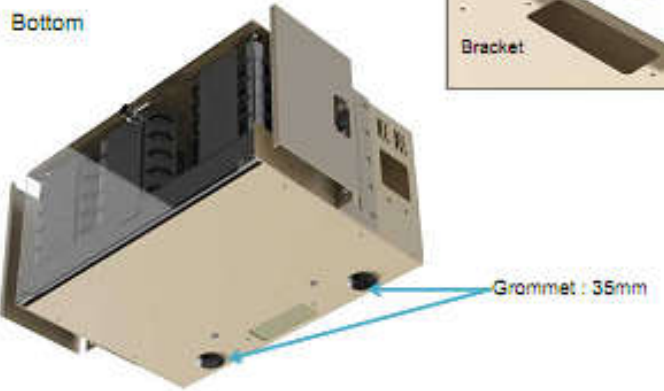
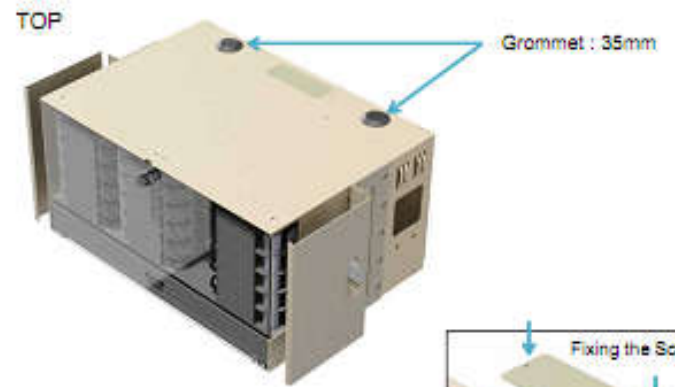

IMÁGENES

