



Chapter-Content	Page
<b>14.0</b> Surface Mounted Boxes	2
<b>14.1</b> Flush Mounted Boxes	9
<b>14.2</b> Distribution Pillar	10

### KRONECTION® Box A-2 for 2 pairs and KRONECTION®-Box A-6 for 6 pairs

Order No.	Distribution Box for 2 pairs	Pack
6430 1 002-00	KRONECTION Box A-2, EVz 83	1 pc

For mounting outdoors, protection type IP 54.  
Cover made of glass fiber-reinforced polyester, colour grey.  
Box made of highly impact-resistant polypropylene, colour black.  
Wall or pole mounting.  
Dimensions: 109x79x48 mm (HxWxD)

Order No.	Pole mounting	Pack
6432 2 006-00	KRONECTION Box A-2/6/10 pole mounting	1 pc

For mounting straps up to 21 mm width.

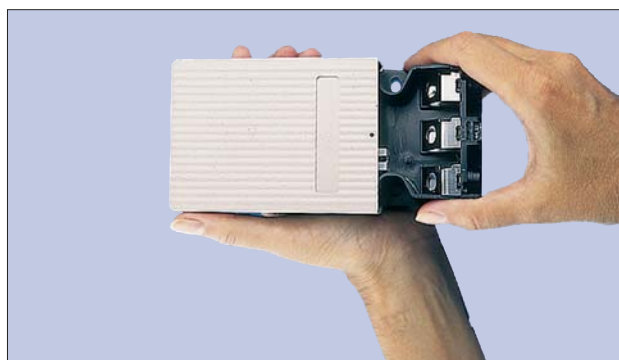

Order No.	Overvoltage protection for KRONECTION Box-A2	Pack
-----------	--	------

6430 2 001-00	LSA-GDT Magazine 8/2 for 4 GDTs 8x6	1 pc
---------------	-------------------------------------	------

6717 3 343-01	GDT 8x6, MK, 230V, 10kA	1 pc
---------------	-------------------------	------

6417 2 010-00	GDT Fail-safe	1 pc
---------------	---------------	------

Per magazine 4 pcs overvoltage arrestors GDT 8x6 and 4 pcs fail-safes are necessary.

Order No.	Test-adapter	Pack
6430 2 003-00	LSA Test adapter 8/1	1 pc

For KRONECTION-Box A-2, A-6, A-10, for connecting 1 pair of the LSA-PLUS connection element with two 4mm banana plugs.



Order No.	Distribution Box for 6 pairs	Pack
6431 1 002-00	KRONECTION Box A-6	1 pc

For mounting outdoors, protection type IP 54.  
Cover made of glass fiber-reinforced polyester, colour grey.  
Box made of highly impact-resistant polypropylene, colour black.  
Wall or pole mounting.  
Dimensions: 141x125x55 mm (HxWxD)

Order No.	Pole mounting	Pack
6432 2 006-00	KRONECTION Box A-2/6/10 pole mounting	1 pc

For mounting straps up to 21 mm width.

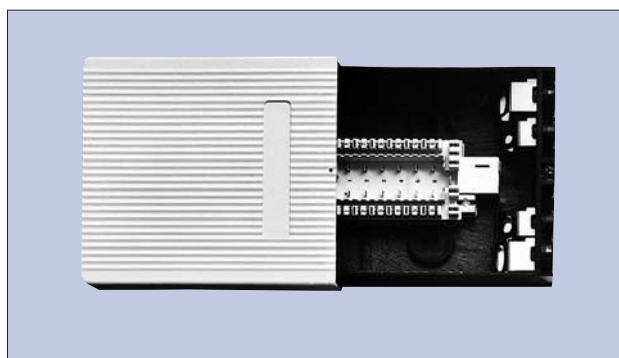

Order No.	Overvoltage protection for KRONECTION Box-A6	Pack
-----------	--	------

6431 2 001-00	LSA-GDT Magazine 8/6 for 12 GDTs 8x6	1 pc
---------------	--------------------------------------	------

6717 3 343-01	GDT 8x6, MK, 230V, 10kA	1 pc
---------------	-------------------------	------

6417 2 010-00	GDT Fail-safe	1 pc
---------------	---------------	------

Per magazine 12 pcs overvoltage arrestors GDT 8x6 and 12 pcs fail-safes are necessary.

Order No.	Test-adapter	Pack
6430 2 003-00	LSA Test adapter 8/1	1 pc

For KRONECTION-Box A-2, A-6, A-10, for connecting 1 pair of the LSA-PLUS connection element with two 4mm banana plugs.

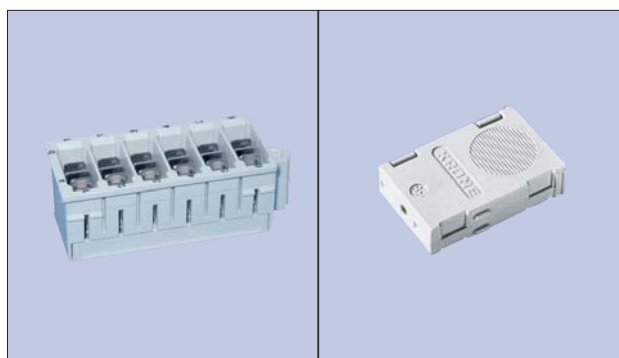

### KRONECTION® Box A-10 for 10 pairs

Order No.	Distribution Box for 10 pairs	Pack
6432 1 002-00	KRONECTION Box A-10, EVz85	1 pc

For mounting outdoors, protection type IP 54.  
 Cover made of glass fiber-reinforced polyester, colour grey.  
 Box made of highly impact resistant polypropylene, colour black.  
 Wall or pole mounting.  
 Dimensions: 181x139x55 mm (HxWxD)

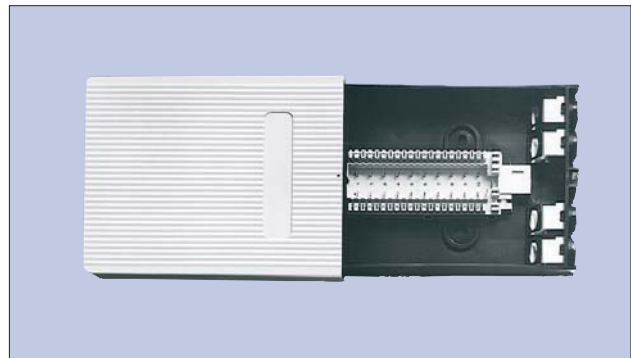

Order No.	Pole mounting	Pack
6432 2 006-00	KRONECTION Box A-2/6/10 pole mounting	1 pc

For mounting straps up to 21 mm width.



Order No.	Overvoltage protection for KRONECTION Box-A10	Pack
6432 2 001-00	LSA-GDT Magazine 8/10 for 20 GDT 8x6	1 pc
6717 3 343-01	GDT 8x6, MK, 230V, 10kA	1 pc
6417 2 010-00	GDT Fail-safe	1 pc

Per magazine 20 pcs overvoltage arrestors GDT 8x6 and 20 pcs fail-safes are necessary.

Order No.	Test-adapter	Pack
6430 2 003-00	LSA-Test-adapter 8/1	1 pc

For KRONECTION-Box A-2, A-6, A-10, for connecting 1 pair of the LSA-PLUS connection element with two 4mm banana plugs.

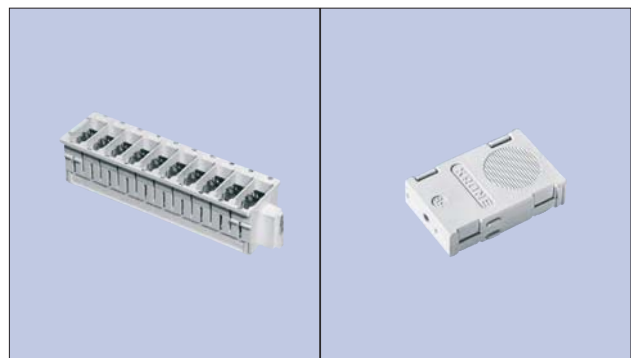

Order No.	Cylinder lock	Pack
6432 3 018-00	KRONECTION Box A-10 Cylinder lock	1 pc

GEKO lock with KRONE locking system.

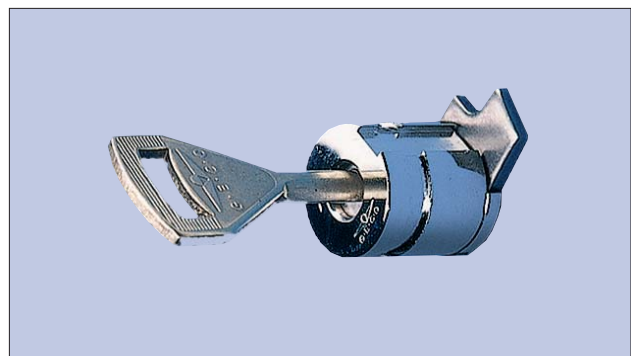

### KRONECTION® Box A-30 for 30 pairs and KRONECTION Box A-100 for 100 pairs

Order No.	A-30 for LSA-PLUS 2/10	Pack
6541 1 003-00	KRONECTION Box A-30 for LSA-PLUS 2/10	1 pc

Empty box with LSA-PLUS backmount frame 2/10 for 30 pairs.

Order No.	A-30 for LSA-PLUS 1/10	Pack
6541 1 002-00	KRONECTION Box A-30 for LSA-PLUS 1/10	1 pc

Empty box prepared for 2 LSA-PLUS connection modules 1/10, 20 pairs.

Order No.	A-30 for Dropwire	Pack
6541 1 001-00	KRONECTION Box A-30 for LSA-PLUS 5/10	1 pc

Empty box prepared for 1 LSA-PLUS Dropwire connection module 5/10, for 10 pairs.

For mounting outdoors, protection type IP 55.  
Cover and box made of glass fiber-reinforced polyester, colour grey.  
Wall or pole mounting.  
Dimensions : 242x169x100 mm (HxWxD)



Order No.	A-100 for LSA-PLUS 2/10	Pack
6542 1 003-00	KRONECTION Box A-100 for LSA-PLUS 2/10	1 pc

Empty box with LSA-PLUS backmount frame 2/10 for 100 pairs.

Order No.	A-100 for LSA-PLUS 1/10	Pack
6542 1 002-00	KRONECTION Box A-100 for LSA-PLUS 1/10	1 pc

Empty box prepared for 4 LSA-PLUS connection modules 1/10, 40 pairs.

Order No.	A-100 for Dropwire	Pack
6542 1 001-00	KRONECTION Box A-100 for LSA-PLUS 5/10	1 pc

Empty box prepared for 2 LSA-PLUS Dropwire connection modules 5/10, for 20 pairs.

For mounting outdoors, protection type IP 55.  
Cover and box made of glass fiber-reinforced polyester, colour grey.  
Wall or pole mounting.  
Dimensions: 377x193x110 mm (HxWxD)



### Accessories for KRONECTION® Box A-30 and A-100

Order No.	Locks	Pack
6541 2 006-00	KRONECTION Box A-30/100 Lock, locking system 19, without key	1 pc
5267 3 383-52	KRONECTION Box A-30/100 key, locking system 19	1 pc
6541 2 006-02	KRONECTION Box A-30/100 lock, Eurolocks, with 2 keys	1 pc

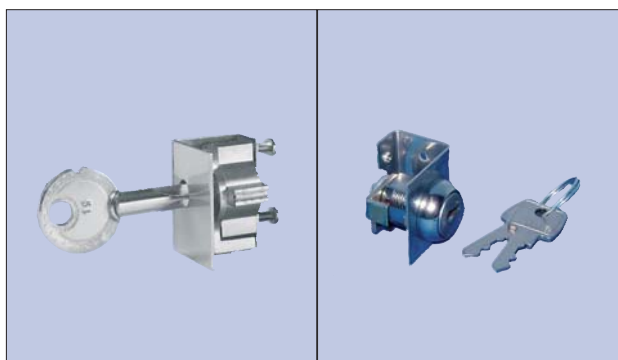

Order No.	Pole mounting	Pack
6541 2 005-00	KRONECTION Box A-30/100 pole mounting	1 pc

For mounting straps up to 21 mm width.

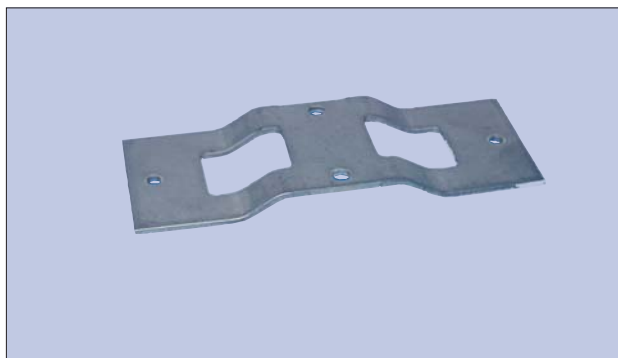

Order No.	Earthing clamp for cable sheath	Pack
6541 2 003-00	KRONECTION Box-A-30/100 Earthing clamp for cable sheath	1 pc

For earthing of branching cables, is mounted next to the central cable sheath earthing clamp for the incoming cable.

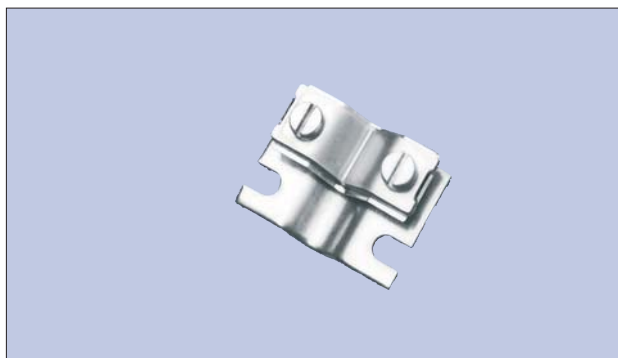

Order No.	Sealing plugs	Pack
6541 3 012-01	KRONECTION Box A-30/100 sealing plug for 10 cables Ø 4-6 mm	1 pc





## KRONECTION® Box A-200

Order No.	A-200 with backmount frame	Pack
0416 1 003-30	KRONECTION Box A-200 for LSA-PLUS 2/10	1 pc

Empty box with cylinder lock, 2 keys and LSA-PLUS backmount frame 2/10 for 200 pairs.

Order No.	A-200 with PROFIL rack	Pack
0416 1 003-90	KRONECTION Box A-200 for LSA-PROFIL 2/10	1 pc

Empty box prepared for cylinder lock and with LSA-PROFIL Rack 2/10 for 200 pairs.

Order No.	A-200 with mounting plate	Pack
0416 1 002-30	KRONECTION Box A-200 with mounting plate	1 pc

Empty box with cylinder lock, 2 keys and mounting plate for individual configuration.

For mounting outdoors, protection type IP 55.

Cover and box made of glass fiber-reinforced polyester, colour grey.

Wall or pole mounting.

Dimensions: 702x237x146 mm (HxWxD)



Order No.	Cylinder lock	Pack
0416 2 003-82	KRONECTION Box A-200 cylinder lock kit with 2 keys	1 pc



Order No.	Pole mounting	Pack
0416 2 003-81	KRONECTION Box A-200 pole mounting	1 pc

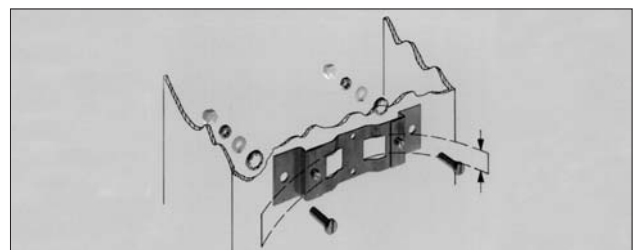

Order No.	Earth contact strip	Pack
6034 3 084-01	KRONECTION Box Earth contact strip	1 pc



### UniBox I and UniBox II

Order No.	UniBox I for LSA-PLUS, 30 pairs	Pack
7016 1 103-00	UniBox-I-LSA-PLUS, without lock	1 pc
7016 1 133-00	UniBox-I-LSA-PLUS, with lock	1 pc

Empty box with LSA-PLUS backmount frame 2/10 for 30 pairs.  
Optional with or without Eurolocks lock (lock is not upgradeable).

Order No.	UniBox I for LSA-PROFIL, 30 pairs	Pack
7016 1 105-00	UniBox-I-LSA-PROFIL without lock	1 pc
7016 1 135-00	UniBox-I-LSA-PROFIL with lock	1 pc

Empty box with LSA-PROFIL Frame 2/10 for 30 pairs, or for 16 pairs with LSA-PROFIL Disconnection modules 2/8xabs.  
Optional with or without Eurolocks lock (lock is not upgradeable).



#### Technical Data: UniBox I

Box for wall mounting or fixing on poles with mounting straps.  
Cover 135° swiveling. Protection type IP54.  
Dimensions: 196x214x107 mm (HxWxD)  
Materials: Plastic, PBT and PP, flammability: according UL94, V0.  
All metal parts are made of stainless steel.

Order No.	UniBox II for LSA-PLUS, 50 pairs	Pack
7016 1 203-00	UniBox-II-LSA-PLUS, without lock	1 pc
7016 1 233-00	UniBox-II-LSA-PLUS, with lock	1 pc

Empty box with LSA-PLUS backmount frame 2/10 for 50 pairs.  
Optional with or without Eurolocks lock (lock is not upgradeable).

Order No.	UniBox II for LSA-PROFIL, 50 pairs	Pack
7016 1 205-00	UniBox-II-LSA-PROFIL without lock	1 pc
7016 1 235-00	UniBox-II-LSA-PROFIL with lock	1 pc

Empty box with LSA-PROFIL-Frame 2/10 for 50 pairs, or for 32 pairs with LSA-PROFIL-Disconnection modules 2/8xabs.  
Optional with or without Eurolocks lock (lock is not upgradeable).



#### Technical Data: UniBox II

Box for wall mounting or fixing on poles with mounting straps.  
Cover 135° swiveling. Protection type IP54.  
Dimensions: 264x214x107 mm (HxWxD)  
Materials: Plastic, PBT and PP  
Flammability: According to UL94, V0.  
All metal parts are made of stainless steel.

## UniBox III and UniBox IV

Order No.	UniBox III for LSA-PLUS, 100 pairs	Pack
7016 1 303-00	UniBox-III-LSA-PLUS, without lock	1 pc
7016 1 333-00	UniBox-III-LSA-PLUS, with lock	1 pc

Empty box with LSA-PLUS backmount frame 2/10 for 100 pairs.  
Optional with or without Eurolocks lock (lock is not upgradeable).

Order No.	UniBox III for LSA-PROFIL, 100 pairs	Pack
7016 1 305-00	UniBox-III-LSA-PROFIL without lock	1 pc
7016 1 335-00	UniBox-III-LSA-PROFIL with lock	1 pc

Empty box with LSA-PROFIL Frame 2/10 for 100 pairs, or for 64 pairs with LSA-PROFIL Disconnection modules 2/8xabs.  
Optional with or without Eurolocks lock (lock is not upgradeable).



## Technical Datas: UniBox III

Box for wall mounting or fixing on poles with mounting straps.

Cover 135° swiveling. Protection type IP54.

Dimensions: 376x214x107 mm (HxWxD)

Materials: Plastic, PBT and PP, flammability: according to UL94, V0.  
All metal parts are made of stainless steel.

Order No.	UniBox IV for LSA-PLUS, 150 pairs	Pack
7016 1 403-00	UniBox-IV-LSA-PLUS, without lock	1 pc
7016 1 433-00	UniBox-IV-LSA-PLUS, with lock	1 pc

Empty box with LSA-PLUS backmount frame 2/10 for 150 pairs.  
Optional with or without Eurolocks lock (lock is not upgradeable).

Order No.	UniBox IV for LSA-PROFIL, 150 pairs	Pack
7016 1 405-00	UniBox-IV-LSA-PROFIL without lock	1 pc
7016 1 435-00	UniBox-IV-LSA-PROFIL with lock	1 pc

Empty box with LSA-PROFIL Frame 2/10 for 150 pairs, or for 96 pairs with LSA-PROFIL Disconnection modules 2/8xabs.  
Optional with or without Eurolocks lock (lock is not upgradeable).



## Technical Data: UniBox IV

Box for wall mounting or fixing on poles with mounting straps.

Cover 135° swiveling. Protection type IP54.

Dimensions: 489x214x107 mm (HxWxD)

Materials: Plastic, PBT and PP

Flammability: According to UL94, V0.

All metal parts are made of stainless steel.



### KRONECTION® Box A-50U and KRONECTION® Box A-200U

Order No.	A-50 U for 50 pairs	Pack
6838 1 001-00	KRONECTION Box A-50U with lock	1 pc

Empty box with backmount frame for 5 LSA-PLUS Modules 2/10 and lock with 2 keys

Order No.	A-200 U for 200 pairs	Pack
0416 1 001-21	KRONECTION Box A-200U with lock	1 pc

Empty box with lock and 2 keys

Order No.	Accessories	Pack
6034 3 084-01	KRONECTION Box A Shield connection cord	1 pc
6619 2 053-00	Flat iron clamp 26-30 mm with backing plate	1 pc
6619 2 054-00	Flat iron clamp 30-34 mm with backing plate	1 pc

#### Design:

The KRONECTION® Box A-50U (Box A-200U) is a flush mounted box with a “camouflage” for external walls. It can be integrated inconspicuously and effectively into any facade design because of its flush fitting with the plaster, and it can be optically hidden simply by painting it with the facade paint.

#### Features and technical capabilities:

- Prepared for LSA-PLUS Modules.
- Overvoltage protection magazines of LSA-PLUS series 2/10 can be used.
- A removable clip-on door ensures unhindered access to the mounting area.
- The textured surface makes it difficult to stick posters.
- It is possible to spray a marking, e.g. a customer logo, onto the door.
- A flush mounting levelling frame with a seal to the wall covers the plaster facing and makes flush fitting with the facade easier.
- An earth bar serves to connect the shield contacts of layer shield cables and earth wires.
- A central screw enables an external earth to be connected.
- Clip-on door with safety lock incl. 2 keys (standard version).
- Dirt protector as plastering aid included.

#### Benefits:

- Maintenance-free due to long life plastics and non-corrosive metal parts. This minimizes service and maintenance costs.

#### Technical data:

##### Materials:

Housing:	glass fiber-reinforced polyester
Colour:	grey (similar RAL 7032)
Cable entry points:	Synthetic rubber
Metal parts:	Stainless steel
Protection class:	IP 54 acc. to IEC 529
Flammability class:	UL 94-V0
Ambient temperature:	-30 ... +80 °C



KRONECTION Box A-50U  
Dimensions : 270x250x113 mm (HxWxD)



KRONECTION Box A-200U  
Dimensions: 708x285x138 mm (HxWxD)

# 14.2

## Distribution Pillars

### Outdoor Distribution Cabinets

#### KRONECTION® Boxes with pedestal (Distribution pillars)

Order No.	Distribution pillar for 100 pairs	Pack
6976 1 001-02	VzSv 100	1 pc

Free standing Distributor with LSA-PLUS backmount frame 2/10 for 100 pairs.

#### Technical data:

Housing:	glass fiber-reinforced polyester
	Metal parts: stainless steel
Pedestal	metal profile, tin coated
Cable cover:	steel sheet, powder-coated
Colour:	grey similar RAL 7032
Protection class:	IP 54 acc. to IEC 529
Flammability class:	UL 94-V0
Cable entry - Numbers of cables for cable diameter:	

1 x 10 - 30 mm
3 x 10 - 25 mm
12 x 4 - 9 mm

Order No.	Locks	Pack
6541 2 006-00	KRONECTION Box A-30/100 lock, locking system 19, without keys	1 pc
5267 3 383-52	KRONECTION Box A-30/100 key, locking system 19	1 pc
6541 2 006-02	KRONECTION Box A-30/100 lock, Eurolocks with 2 keys	1 pc

Order No.	Distribution pillar for 200 pairs	Pack
6976 1 002-00	VzSv 200 with lock	1 pc

Free standing Distributor with LSA-PLUS backmount frame 2/10 for 200 pairs.

#### Technical data:

Housing:	glass fiber-reinforced polyester
	Metal parts: stainless steel
Pedestal	metal profile, tin coated
Cable cover:	steel sheet, powder-coated
Colour:	grey similar RAL 7032
Protection class:	IP 54 acc. to IEC 529
Flammability class:	UL 94-V0
Cable entry - Numbers of cables for cable diameter:	

2 x 10 - 33 mm
2 x 10 - 19 mm
6 x - 8.5mm

Order No.	Lock	Pack
0416 2 003-82	KRONECTION Box A-200 Lock kit with 2 keys	1 pc

#### Dimensions

